

Model: D-30

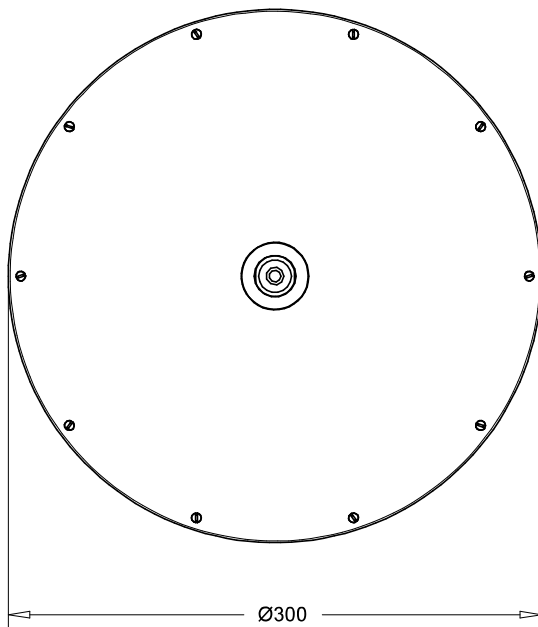
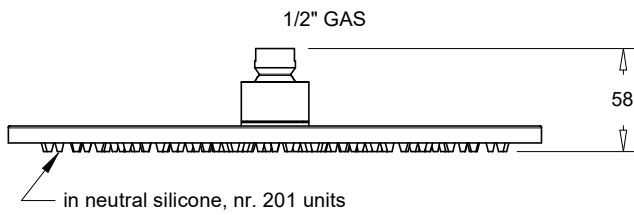
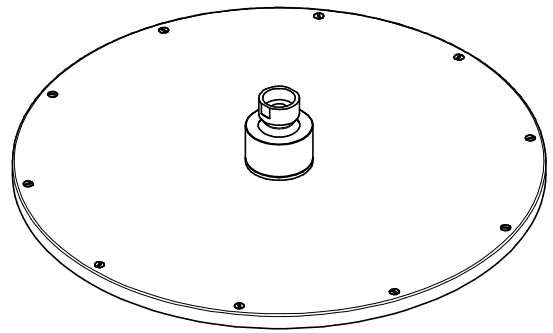
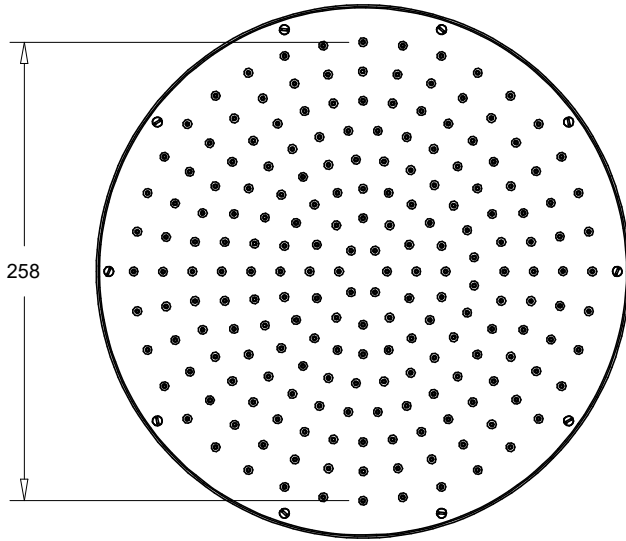

- u.m.: mm
- material: ss aisi 316L,
screws in aisi 316 (A4)
- antilimescale
- inspectable
- versions with and without ball join
(showed with)